

LED Panel Light

Patented design

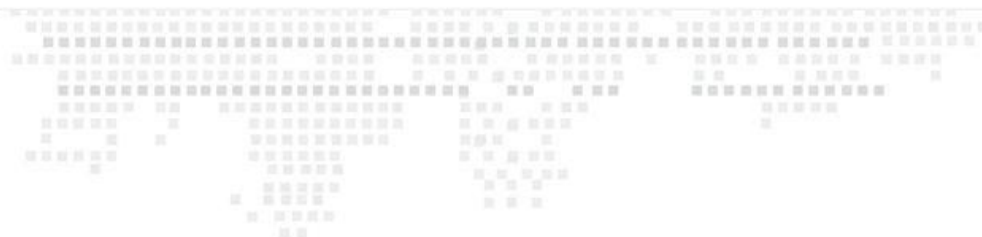

Company Profile

公司简介



Anhui Zerun Optoelectronic Co.,Ltd is one of the largest LED manufacturers which is specialized in LED Panel light.

It is registered in Ma-anshan Economic and Technical Development Zone in 2008. It has more than 300 employees currently with independent property rights of the production workshop 40,000 square meters.

Nowadays, Zerun only focused on LED Panel Light, turning out 200,000 to 300,000 pcs LED panel lights per month. Annual turnover more than 4,000,000 production capacity. Our panels get full TUV GS CE RoHS PAHs ErP SAA UL DLC certifications.

Our factory has been accredited with ISO 9001:2008. Additionally, with well equipped LED lab, complete SMT lines, IES test room and fully automatic aging machines, we can deliver LED panel lights in time. We are always prepare 2000pcs 600x600 panels in stock for some Projects.

For more information please contact us freely or mail to us: sales@zr-led.com.

Company Important Case

大事记

- 2009.4 ● 专注LED光源17年，团队入院再启新征程。
Specialized in SMD encapsulation for LED light source more than 17 years, then start a new journey.
 - 2010.9 ● 整合杭州专业结构团队，进军照明领域。
Worked with the professional technical team in Hangzhou, to entering lighting industry.
 - 2011.6 ● 通过TUV认证，一举中标意大利国家电信
Passed TUV certification, won the bid for the Italian national telecom.
 - 2012.4 ● 成为沃尔玛指定OEM工厂
To be Walmart OEM factory.
 - 2013.5 ● 月出口面板灯首度超过5万片
Monthly exports in LED panel lights more than 50,000 pcs for the first time.
 - 2014.9 ● 中标英国伦敦机场改造项目
Won the bid for London airport energy saving reconstruction project.
 - 2015.4 ● 成为欧司朗、施耐德等国际顶级品牌供应商
Become OSRAM, Schneider and other international top brand supplier.
 - 2015.9 ● 全面通过欧、美、澳、亚各国主要认证
Got authoritative certificates (TUV ,CE,UL,FCC,DLC, SAA), which is famous in Europe, USA, Australia, Asia and etc.
 - 2015.12 ● 单月出口面板灯首度超过10万片
Monthly exports in LED panel lights more than 100,000 pcs at a time.
 - 2016.3 ● 与英国HERO公司达成欧洲区销售代理合作
Merger Led HERO UK company, establish UK branch .
 - 2017.9 ● 与美国TONGSHENG INC公司达成美国销售代理合作
Collaborated with US TONGSHENG INC as American sales agency.
 - 2017.12 ● 首轮定增，新三板完成股改和挂牌进行时
Completed share reform and first round scheduled increase, the new three board listing in progress.
 - 2018.8 ● 产能增加，扩建厂房
With strong business volume growth, we enlarged factory to make sure production capacity enhanced.
- 精彩继续
To be continued...

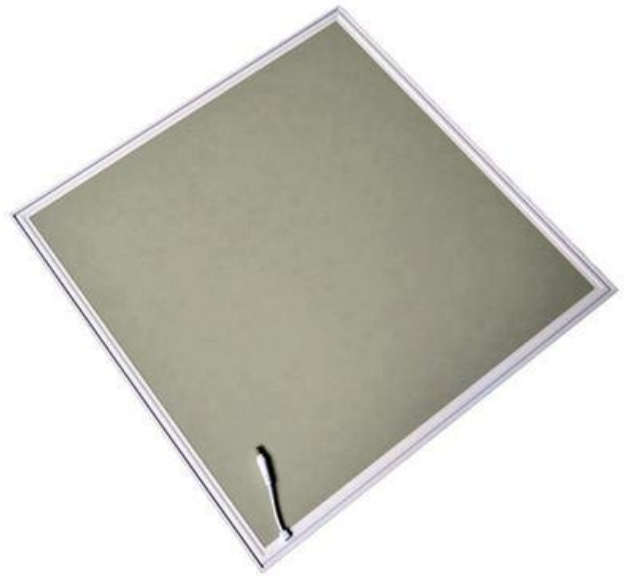

OSRAM



San'an



AC200-240V

Frequency

50/60Hz



100LM/W



50,000



>80

IP

40

UGR

22

3000-6500K



Product Lines Overview (Optional Panels)

C2-6 series/CE RoHS LED PANEL LIGHT

Spec	Wattage	LPW	Input Voltage	PF	CRI	CCT	Region
595*595*8mm	40W	90-100LM/W	200~240Vac	0.95	CRI>80	3000~6500K	Standard
295*1195*8mm	40W	90-100LM/W	200~240Vac	0.95	CRI>80	3000~6500K	Standard

ISO 9001:2015





Patented design
New Series



Product Features

- Edge-lit LED for superior white and brightness uniformity
- Higher lumen efficacy, range from 100-130lm/W
- Anti-yellowing, heat-resistance LGP and PMMA LGP for option, good quality assurance
- Non dimmable/ 1-10V dimmable/Dali dimmable available.
- Screwless frame at the back, with no junction gap at the top, ZERUN's patented design.
- IP40 protection against dust
- Auto-painting production line for quick delivery time
- Suspension kit, Surface mounting frame available

 Frequency	 lm	 h	 Ra	IP	UGR	3000-6500K
AC200-240V	50/60Hz	100LM/W	>80	40	22	

Product Lines Overview (Optional Panels)

K3 /CE RoHS LED PANEL LIGHT

Spec	Wattage	LPW	Input Voltage	PF	CRI	CCT	Region
595*595*10mm	40W	100-130LM/W	100~240Vac	0.95	CRI>80	3000~6500K	Standard
295*1195*10mm	40W	100-130LM/W	100~240Vac	0.95	CRI>80	3000~6500K	Standard

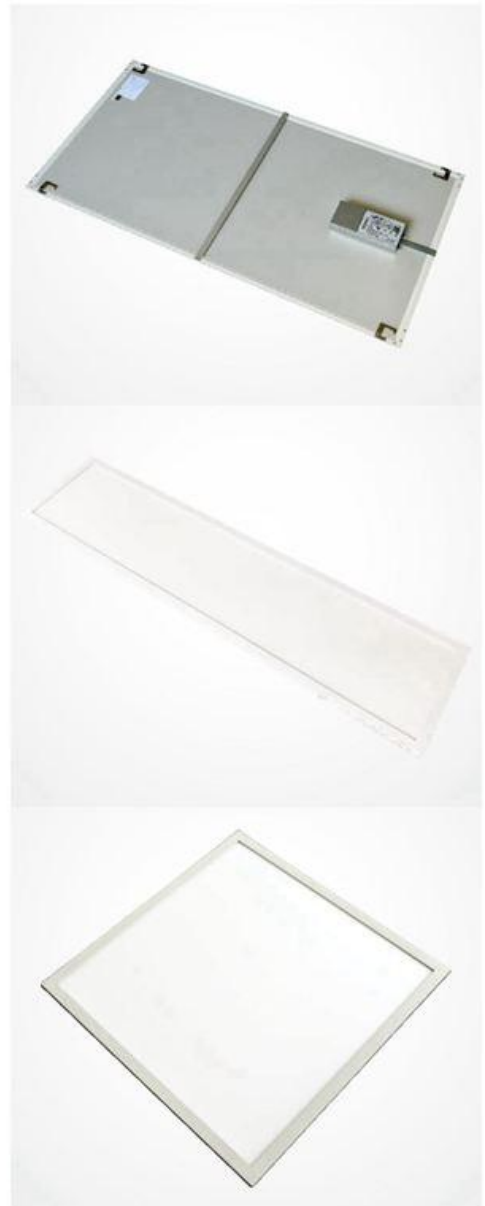

Features

Luminaires for Ambient Lighting of Interior Commercial

- Edge-lit LED for superior white and brightness uniformity
- Mounting clips set on the back which keep well fasten to T-Bar ceiling
- Directly replaces fluorescent fixture and tube
- Lasts 60% longer than standard troffer lighting
- Low energy consumption, Low heat dissipation
- 50,000 hours life expectancy
- 0-10V,PWM and Rx dimmable versions designed with three in one
- Durable diffuser for easy cleaning
- Environmentally positive - RoHS compliant
- Suitable for dry and damp locations
- Type IC rated

Product Lines Overview (Optional Panels)

C3-2 series / UL ETL DLC FCC LED FLAT PANEL

Spec	Wattage	LPW	Input voltage	PF	Dimmable	CRI	CCT	Region
2'x 2'FT	30W	125LM/W	100-347Vac	0.95	Yes	CRI>80	3500K/4000K/5000K	North America
2'x 2'FT	36W	100LM/W	100-347Vac	0.95	Yes	CRI>80	3500K/4000K/5000K	North America
1'x 4'FT	30W	125LM/W	100-347Vac	0.95	Yes	CRI>80	3500K/4000K/5000K	North America
1'x 4'FT	36W	100LM/W	100-347Vac	0.95	Yes	CRI>80	3500K/4000K/5000K	North America
2'x 4'FT	40W	125LM/W	100-347Vac	0.95	Yes	CRI>80	3500K/4000K/5000K	North America
2'x 4'FT	50W	100LM/W	100-347Vac	0.95	Yes	CRI>80	3500K/4000K/5000K	North America

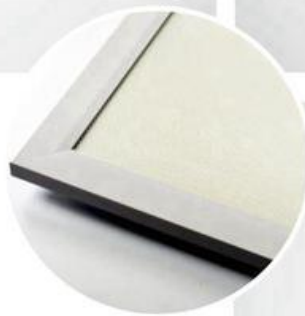

Product Features

- Screwless frame patented design.
- Edge-lit LED for superior white and brightness uniformity
- No EVA Foam included, without affecting performance, fire safety is higher
- Low energy consumption, Low heat dissipation
- 50,000 hours life expectancy
- Durable diffuser for easy cleaning
- Surface mounting frame available
- Environmentally positive - RoHS compliant
- IP40 protection against dust.

AC200-240V	Frequency 50/60Hz	100LM/W	50,000 h	>80	IP 40	UGR 22	3000-6500K
------------	-----------------------------	---------	----------	-----	-----------------	------------------	------------

Product Lines Overview (Optional Panels)

U2 /CE RoHS LED PANEL LIGHT

Spec	Wattage	LPW	Input Voltage	PF	CRI	CCT	Region
595*595*10mm	40W	100-120LM/W	100~240Vac	0.95	CRI>80	3000-6500K	Standard
295*1195*10mm	40W	100-120LM/W	100~240Vac	0.95	CRI>80	3000-6500K	Standard

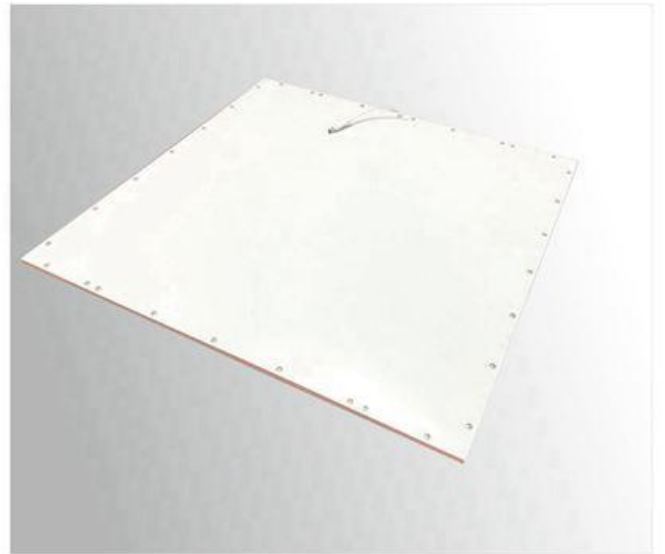

POWER Led SMD+ TECHNOLOGY

Product Features

The whole panel divide to three parts:

- 1. LED strips module , the LED have Lm80
- 2. Panel module (include LGP,Diffuser, Reflective paper, Backplate,Frames)
- 3. LED Driver

Only three steps the panel can be assembled.



AC200-240V	Frequency 50/60Hz	lm 100LM/W	h 50,000	Ra >80	IP 40	UGR 22	3000-6500K
------------	-----------------------------	----------------------	--------------------	------------------	-----------------	------------------	------------

Product Lines Overview (Optional Panels)

SKD/CE RoHS LED PANEL LIGHT

Spec	Wattage	LPW	Input Voltage	PF	CRI	CCT	Region
595*595*10mm	40W	90-100LM/W	100~240Vac	0.95	CRI>80	3000~6500K	Standard

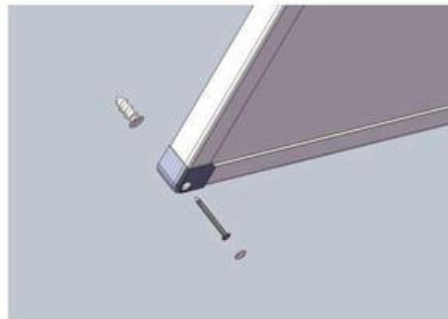
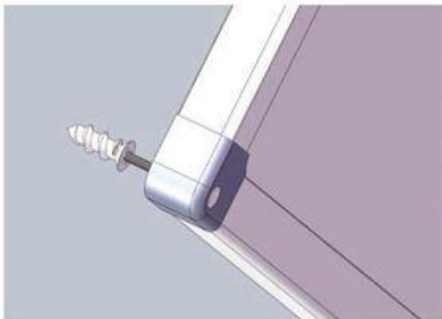
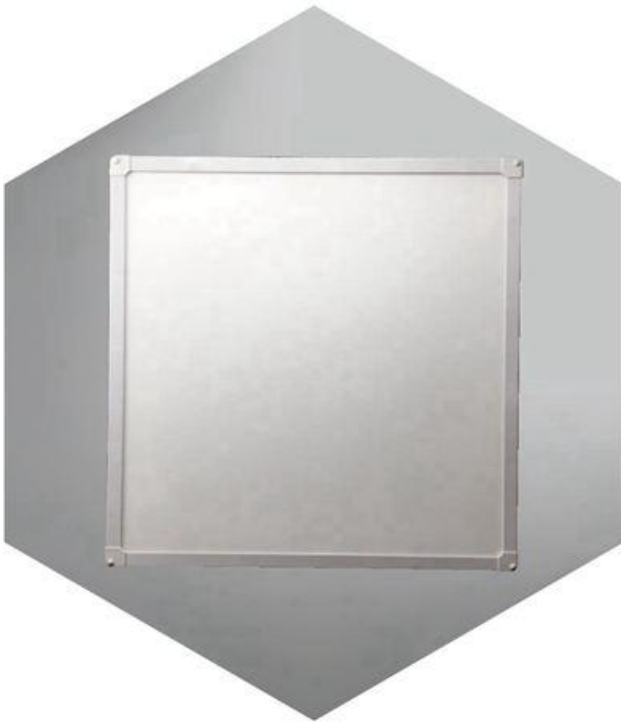

Product Features

产品特性

1. High efficiency & lower power consumption
2. Delivers high brightness & excellent illumination even in high ceiling areas
3. Extraordinary long life of LED'S(over 50,000 burning hrs).LM80 electronic driver (over 30,000 burning hrs.)ensure zero maintenace
4. No UV or IR radiations
5. Environment friendly as it does not contain Mercury
6. Instant light with low running temperatures
7. Excellent CRI

Product Lines Overview (Optional Panels)

X3 series/CE RoHS LED PANEL LIGHT

Spec	Wattage	Luminous Efficiency	Input Voltage	PF	CRI	CCT	Region
595*595*23mm	40W	90LM/W	200-240Vac	0.95	Ra≥80	3000-6500K	Europe
1195*295*23mm	40W	90LM/W	200-240Vac	0.95	Ra≥80	3000-6500K	Europe
640*640*23mm	50W	110LM/W	200-240Vac	0.95	Ra≥80	3000-6500K	South Korea
1280*320*23mm	50W	110LM/W	200-240Vac	0.95	Ra≥80	3000-6500K	South Korea

Installation steps are as follows

1

Ceiling mounting frame installation

Step 1:

The ceiling is drilled and the expansion tube is knocked into the ceiling.

Step 2:

Expansion tube *4

X2/X3 series panel light*1

Expansion screws*4

The expansion screw is fixed in the expansion pipe through the mounting hole.

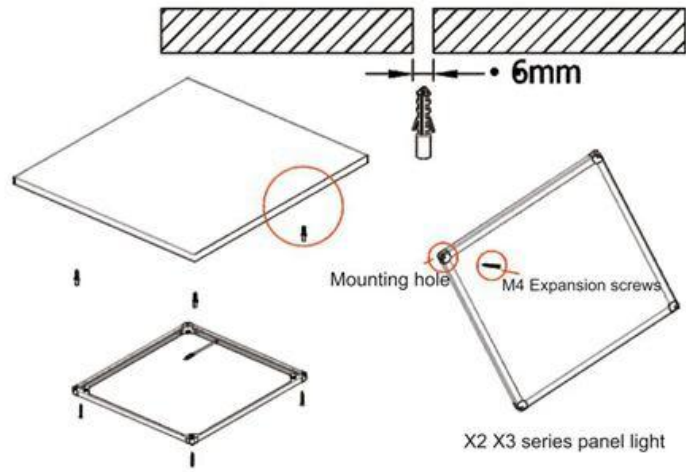

Setup:

1. Digging holes in the roof.
2. Put expansion tube into the holes.
3. Fix X2/X3 panel onto the roof with screws.
4. Put 4 small kits into the holes.

2

Recessed Luminaire

1. Remove the ceiling gypsum board .

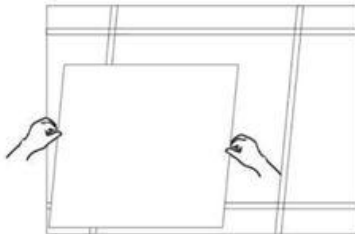

2. Connect the power cord .

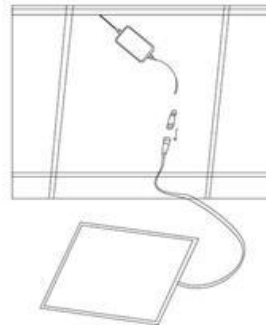

3. Put through the panel light along Ceiling's Diagonal.

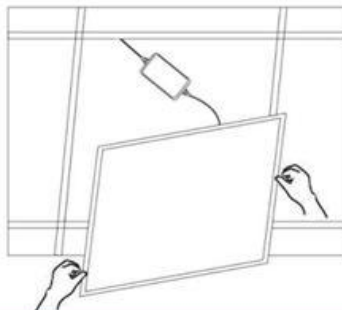

4. Fix the panel light to suitable Place and power on.

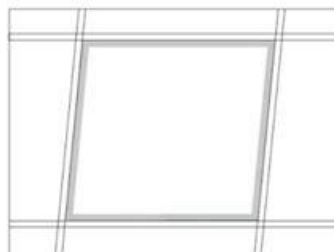

Headquarters

Address: No. 777, Hudong South Road,
Ma-anshan, Anhui China
Tel: +86-555-2110558 / 2110559
Fax: +86-555-2110556
Web: www.zr-led.com
Email: sales@zr-led.com

Branch Company

Address: 2nd Floor, Building 3, technology zone of LZ
university, Yuhang District, Hangzhou, China
TEL: +86(571)-88106010
FAX: +86(571)-88106012
E-mail: service@hzpanel.com

Marketing & Sales

Address: 29th Floor, FOCUS business center, Humin
Road 6088, Minhang District, Shanghai, China
TEL: +86-21-33883881
E-mail: sales@zr-led.com joyce@zr-led.com



Product Features

- 2.4G RF Dimming, Remote Controller.
- One controller can control 100 groups, can set any lamps as a group in a zone.
- Every group can be controlled individually.
- All the lamps can be controlled together.

AC200-240V	Frequency 50/60Hz	100LM/W	50,000 h	>80	IP 40	UGR 22	3000-6500K
------------	-----------------------------	---------	----------	-----	-----------------	------------------	------------

Product Lines Overview (Optional Panels)

A3 series/CCT ADJUSTABLE & DIMMABLE LED PANEL LIGHT.

Spec	Wattage	LPW	Input Voltage	PF	CRI	CCT	Region
595*595*10mm	40W	90LM/W	100-240Vac	0.95	CRI>80	3000-6500K	Standard
620*620*10mm	40W	90LM/W	100-240Vac	0.95	CRI>80	3000-6500K	Standard
295*1195*10mm	40W	90LM/W	100-240Vac	0.95	CRI>80	3000-6500K	Standard



Headquarters

Address: No. 777, Hudong South Road,
Ma-anshan, Anhui China
Tel: +86-555-2110558/2110559
Fax: +86-555-2110556
Web: www.zr-led.com
Email: sales@zr-led.com

Branch Company

Address: 2nd Floor, Building 3, technology zone of LZ
university, Yuhang District, Hangzhou, China
TEL: +86(571)-88106010
FAX: +86(571)-88106012
E-mail: service@hzpanel.com

Marketing & Sales

Address: 29th Floor, FOCUS business center, Humin
Road 6088, Minhang District, Shanghai, China
TEL: +86-21-33883881
E-mail: sales@zr-led.com joyce@zr-led.com

LED Panel Light with Sensor/Remote Control

One-stop Solution for Intelligent Offices

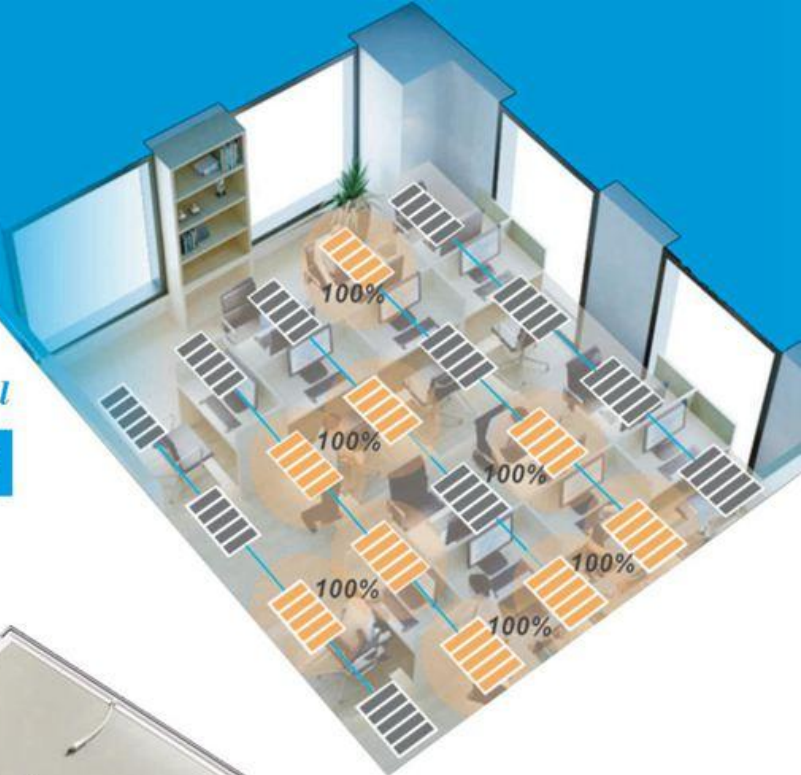

Remove the magnet cover for sensor location.

- Combined with microwave occupancy sensor, daylight sensor and flicker-free dimmable LED driver
- Flexible current settings loop-in/loop-out press fit terminal for fast installation



	Frequency				IP	UGR	3000-6500K
AC200-240V	50/60Hz	100LM/W	50,000	>80	40	22	

Product Lines Overview (Optional Panels)

Z1 series/Intelligent Sensor LED Panel Light

Spec	Wattage	LPW	Input Voltage	PF	CRI	CCT	Region
595*595*10mm	40W	90-100LM/W	220~240Vac	0.95	CRI>80	3000-6500K	Standard
620*620*10mm	40W	90-100LM/W	220~240Vac	0.95	CRI>80	3000-6500K	Standard
295*1195*10mm	40W	90-100LM/W	220~240Vac	0.95	CRI>80	3000-6500K	Standard

LED Panel Light with Daylight Harvesting Driver

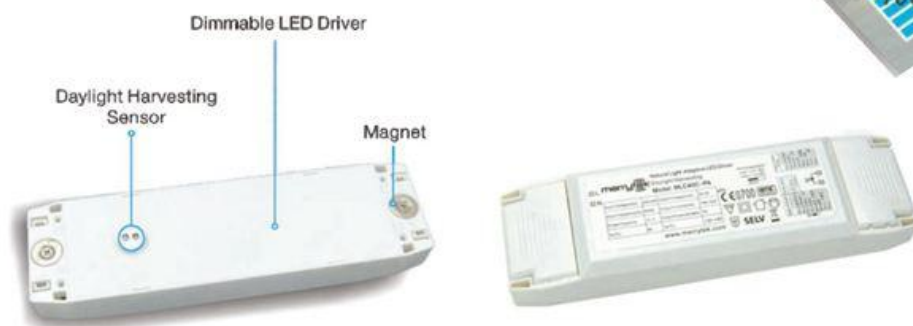
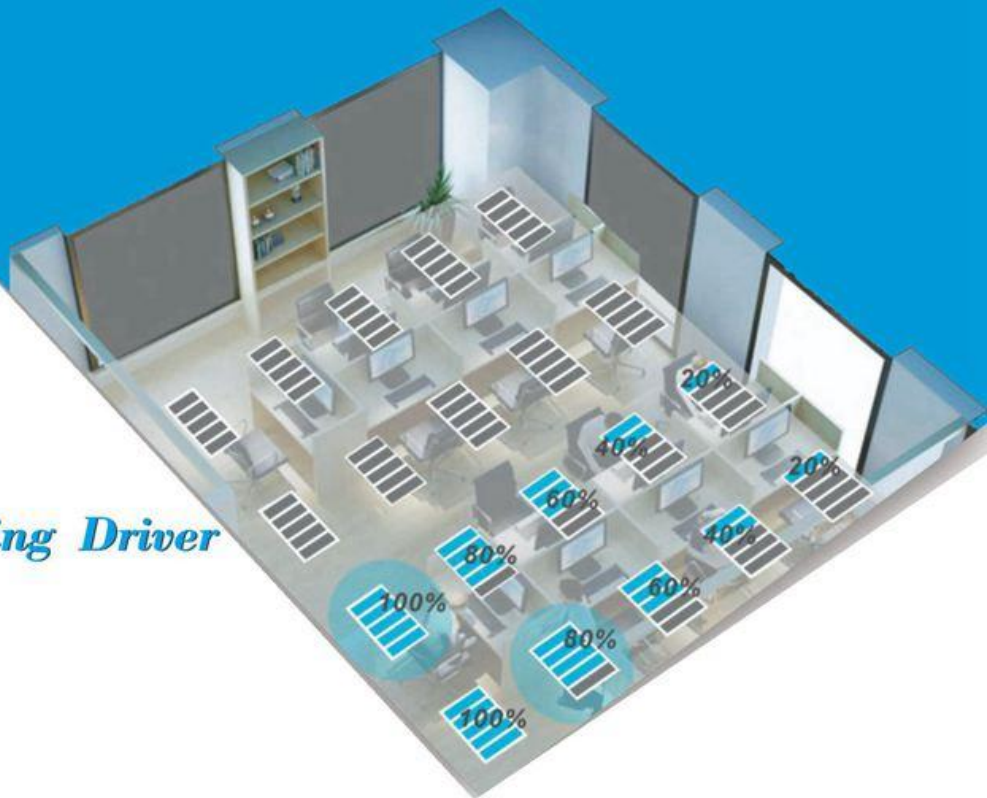

- LED driver integrated daylight harvesting sensor
- Automatically adaptive dimming according to the natural light and save more energy
- Applicable to offices, airports, public places like shopping malls where require minimum light in day time.

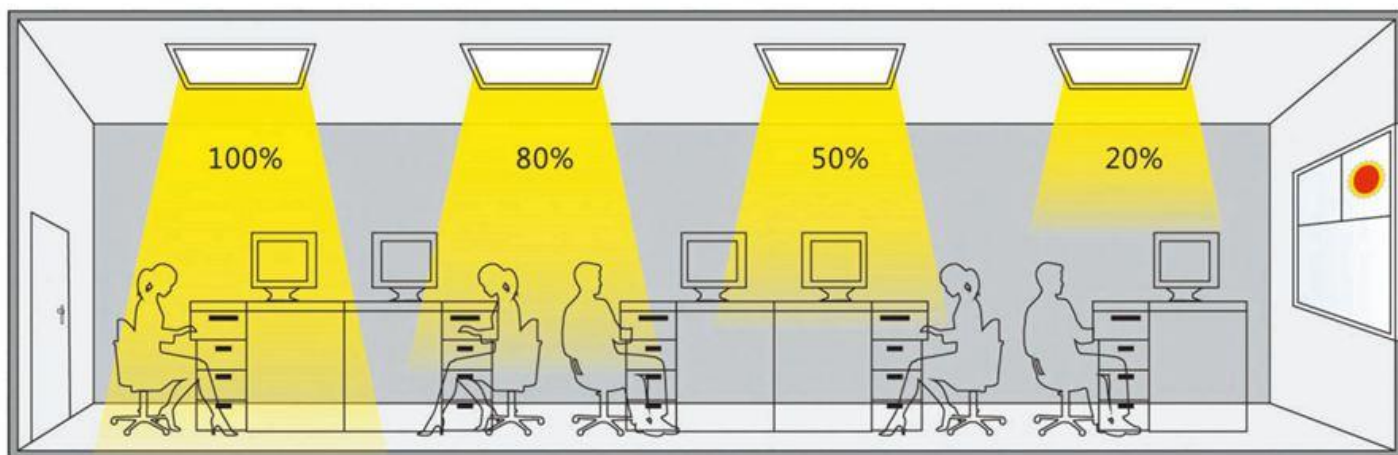

All LED panel lights automatically adaptive dim according to the natural light.

Headquarters

Address: No. 777, Hudong South Road,
Ma-anshan, Anhui China
Tel: +86-555-2110558/2110559
Fax: +86-555-2110556
Web: www.zr-led.com
Email: sales@zr-led.com

Branch Company

Address: 2nd Floor, Building 3, technology zone of LZ
university, Yuhang District, Hangzhou, China
TEL: +86(571)-88106010
FAX: +86(571)-88106012
E-mail: service@hzpanel.com

Marketing & Sales

Address: 29th Floor, FOCUS business center, Humin
Road 6088, Minhang District, Shanghai, China
TEL: +86-21-33883881
E-mail: sales@zr-led.com joyce@zr-led.com



Product Features

High efficiency & lower power consumption
 Delivers high brightness & excellent illumination even in high ceiling areas
 Extraordinary long life of LED'S(over 50,000 burning hrs).LM80
 electronic driver (over 30,000 burning hrs.)ensure zero maintenace
 No UV or IR radiations
 SDCM<3,all light color will be consistent
 IP65

 AC200-240V	Frequency 50 /60Hz	 100LM/W	 50,000	 >80	IP 40	UGR 22	 3000-6500K
---	------------------------------	--	---	--	-----------------	------------------	---

Product Lines Overview (Optional Panels)

IP65 Waterproof LED Panel Light

Spec	Wattage	LPW	Input Voltage	PF	CRI	CCT	Region
595*595*10mm	40W	100LM/W	100-240Vac	0.95	CRI>80	3000-6500K	Standard



Our factory

SMT Workshop



Production Line

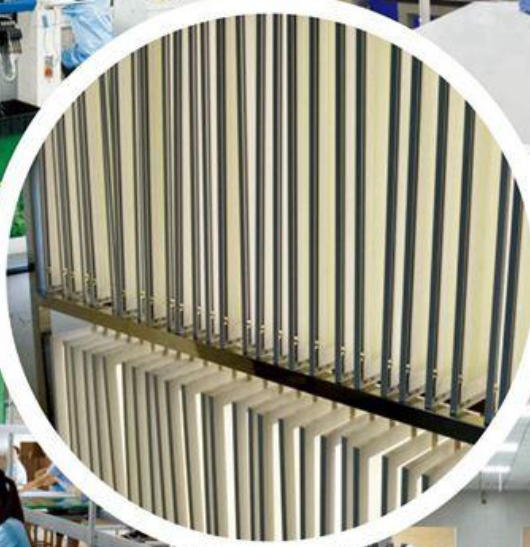

Production Line



SMD Workshop



Headquarters

Address: No. 777, Hudong South Road,
Ma-anshan, Anhui China
Tel: +86-555-2110558/2110559
Fax: +86-555-2110556
Web: www.zr-led.com
Email: sales@zr-led.com

Branch Company

Address: 2nd Floor, Building 3, technology zone of LZ
university, Yuhang District, Hangzhou, China
TEL: +86(571)-88106010
FAX: +86(571)-88106012
E-mail: service@hzpanel.com

Marketing & Sales

Address: 29th Floor, FOCUS business center, Humin
Road 6088, Minhang District, Shanghai, China
TEL: +86-21-33883881
E-mail: sales@zr-led.com joyce@zr-led.com

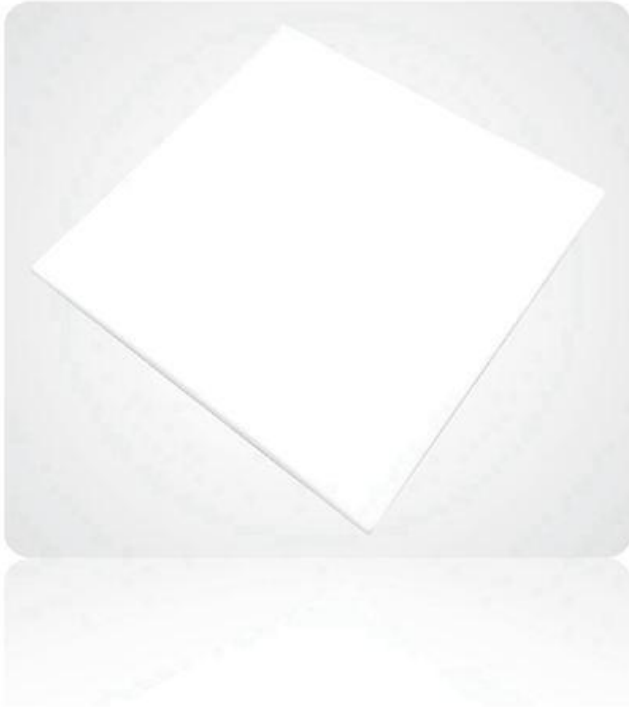

Rimless

LED Panel Light

Product Lines Overview (Optinal Panels)

W1 series /CE RoHS LED PANEL LIGHT

Features

- Edge-lit LED for superior white and brightness uniformity
- No EVA Foam included, without affecting performance, fire safety is higher
- Low energy consumption, Low heat dissipation
- 50,000 hours life expectancy
- Durable diffuser for easy cleaning
- Direct surface mounting for easy installation
- Environmentally positive - RoHS compliant
- IP40 protection against dust.

Spec	Wattage	LPW	Input voltage	PF	Dimmable	CRI	CCT	Region
600*600*30 mm	40W	90 LM/W	220-240Vac	0.95	Optional upgrade	CRI>80	3000K/4000K/6500K	Standard

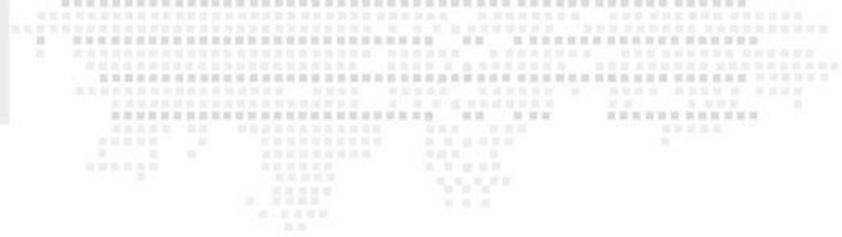

Worldwide

Certifications

System

CB

AUSTRALIA



EUROPE



NORTH AMERICA



ASIA



Headquarters

Address: 安徽省马鞍山市经济技术开发区湖东南路777号
No. 777, Hudong South Road, Ma-anshan, Anhui China
TEL: +86(555)-2110558/2110559
FAX: +86(555)-2110556
WEB: www.zr-led.com
E-mail: sales@zr-led.com

Branch company

Address: 杭州市余杭区良渚街道良渚大学科技园3栋2楼
2nd Floor, Building 3, technology zone of LZ university, Yuhang District, Hangzhou, China
TEL: +86(571)-88106010
FAX: +86(571)-88106012
E-mail: service@hzpanel.com

Marketing & Sales

Address: 上海市闵行区沪闵路6088号龙之梦商务楼29楼
29th Floor, FOCUS business center, Humin Road 6088, Minhang District, Shanghai, China
TEL: +86-21-33883881
E-mail: sales@zr-led.com
joyce@zr-led.com